

Vroom 24 Product Cabinet Installation

1. Locate cardboard template inside the cabinet.

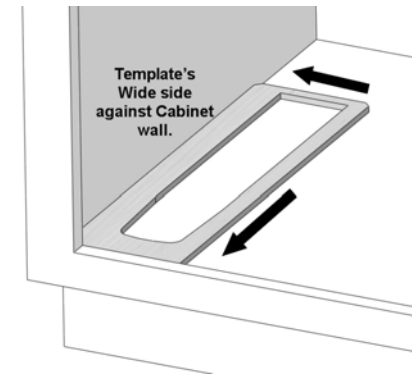

5. Install the Product in the mounting bracket by pushing it into place as shown. It will snap in place when installed correctly.

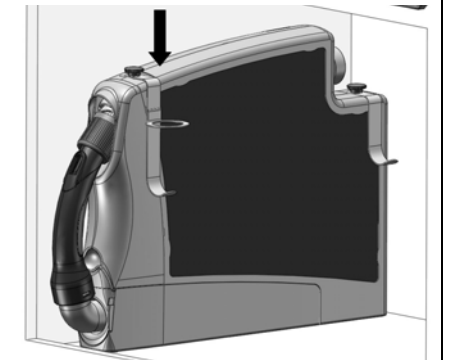

2. Place mounting bracket in template.

Secure with 5 screws as shown.

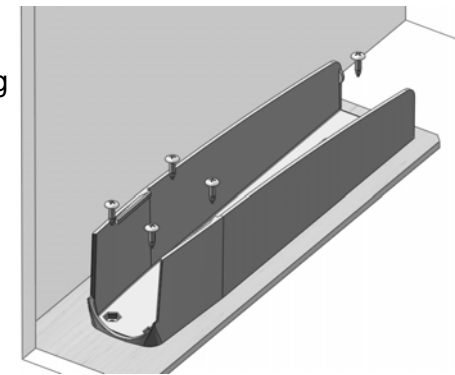

6. Connect the vacuum tubing to the Product's connector on the back as shown. Do NOT glue, press fit only.



3. Remove the cardboard Template.

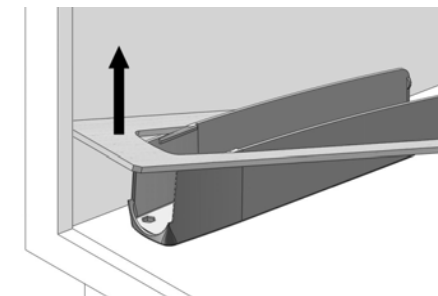



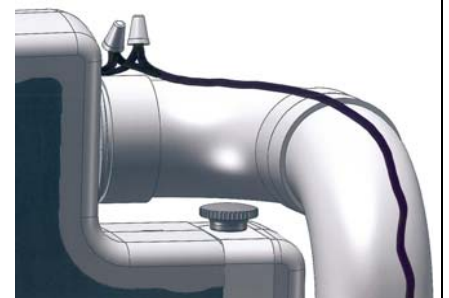

8. Connect the low voltage wires on the back of the unit.

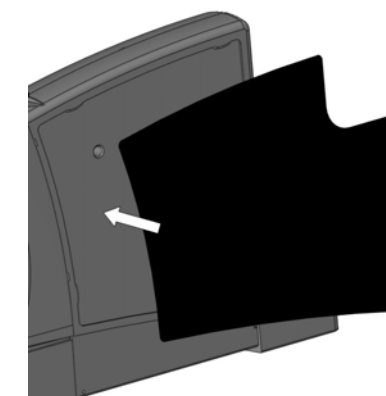

4. Install the side panel. Flex it so the edges tuck under the 5 plastic molded tabs.

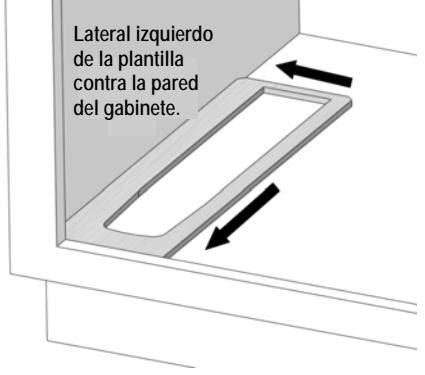
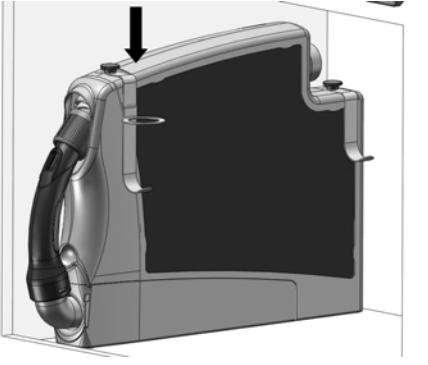
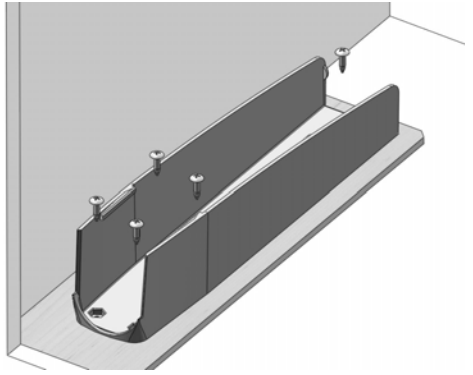

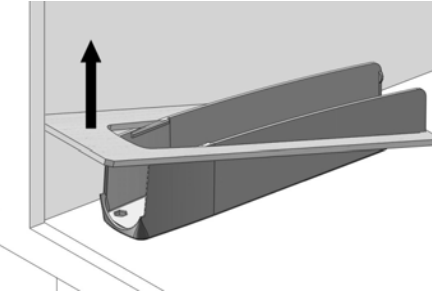
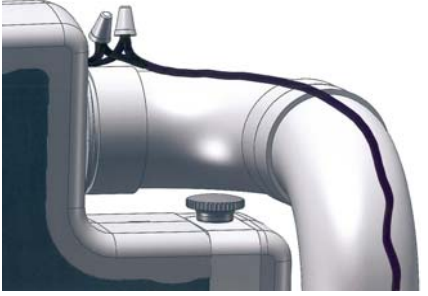
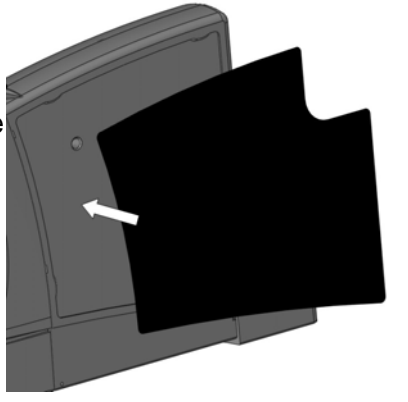
Vroom 24 Instalación del gabinete del producto

<p>1. Coloque la plantilla de cartón dentro del gabinete.</p>  <p>Lateral izquierdo de la plantilla contra la pared del gabinete.</p>	<p>5. Instale el producto en el soporte de montaje presionándolo en su lugar como se muestra. Se insertará a presión en su lugar cuando esté instalado correctamente.</p> 
<p>2. Coloque el soporte de montaje en la plantilla.</p> <p>Fíjelo con 5 tornillos como se muestra.</p> 	<p>6. Conecte el tubo de vacío al conector del producto en la parte posterior como se indica. NO lo pegue, sólo coloque a presión.</p> <p>Por motivos de mantenimiento, no pegue esta conexión.</p> 
<p>3. Retire la plantilla de cartón.</p> 	<p>7. Conecte los cables de baja tensión en la parte posterior de la unidad.</p> 
<p>4. Instale el panel lateral. Flexiónelo de manera que los bordes se metan debajo de las 5 lengüetas plásticas moldeadas.</p> 	

Vroom 24 Installation de l'appareil dans un placard

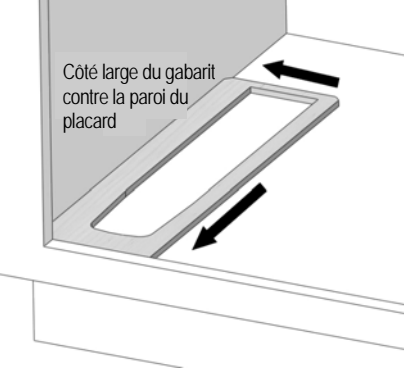
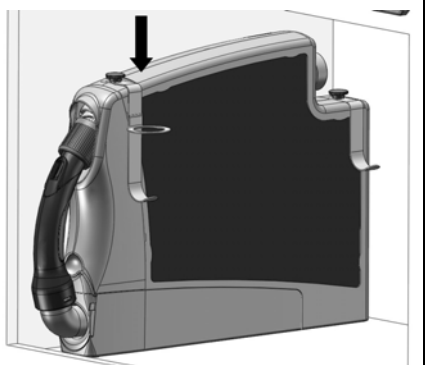
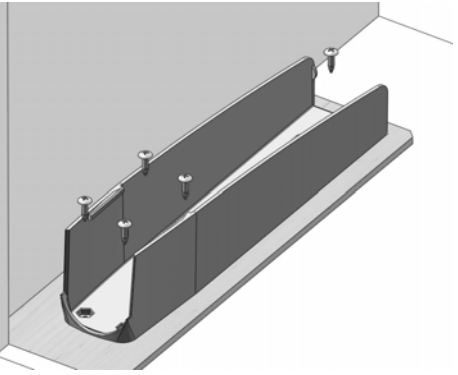
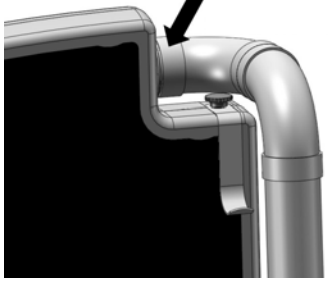
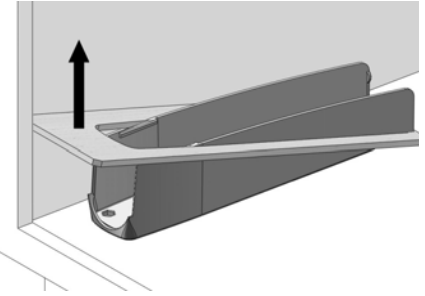
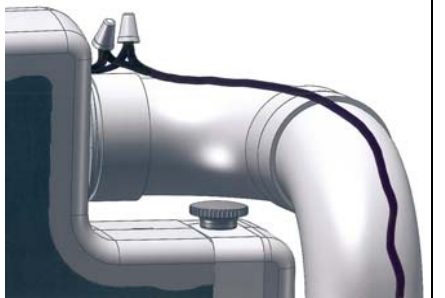
<p>1. Placer le gabarit en carton à l'intérieur du placard.</p>  <p>Côté large du gabarit contre la paroi du placard</p>	<p>5. Installer l'appareil dans le support de fixation en le poussant en place comme illustré. Il s'encliquettera en place s'il est installé correctement.</p> 
<p>2. Placer le support de fixation dans le gabarit.</p> <p>Fixer au moyen de 5 vis comme illustré.</p> 	<p>6. Raccorder le conduit d'aspiration au raccord de l'appareil situé à l'arrière comme illustré. NE PAS coller. Il s'agit d'un ajustement serré seulement.</p> <p>Pour des raisons d'entretien, NE PAS coller ce raccord.</p> 
<p>3. Retirer le gabarit en carton.</p> 	<p>7. Raccorder les câbles basse tension à l'arrière de l'appareil.</p> 
<p>4. Installer le panneau latéral. Le fléchir jusqu'à ce que les bords rentrent sous les 5 languettes en plastique moulé.</p> 